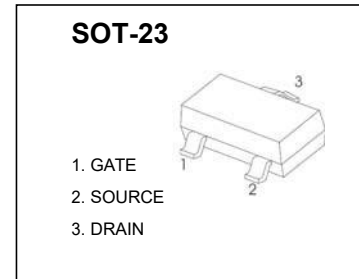

**SOT-23 Plastic-Encapsulate MOSFETS****CC2305** P-Channel MOSFET

$V_{(BR)DSS}$	$R_{DS(on)MAX}$	I_D
-12 V	45mΩ@-4.5V	-4.1A
	60mΩ@-2.5V	
	90mΩ@-1.8V	

**FEATURE**

- TrenchFET Power MOSFET

APPLICATION

- Load Switch for Portable Devices
- DC/DC Converter

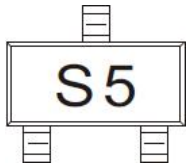
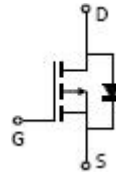
MARKING**Equivalent Circuit****Maximum ratings ($T_a=25^{\circ}\text{C}$ unless otherwise noted)**

Parameter	Symbol	Value	Unit
Drain-Source Voltage	V_{DS}	-12	V
Gate-Source Voltage	V_{GS}	± 8	
Continuous Drain Current	I_D	-4.1	A
Continuous Source-Drain Diode Current	I_S	-0.8	
Maximum Power Dissipation	P_D	0.35	W
Thermal Resistance from Junction to Ambient($t \leq 10\text{s}$)	$R_{\theta JA}$	357	$^{\circ}\text{C}/\text{W}$
Operation Junction and Storage Temperature Range	T_J, T_{STG}	-50 ~ +150	$^{\circ}\text{C}$

MOSFET ELECTRICAL CHARACTERISTICS

$T_a=25\text{ }^\circ\text{C}$ unless otherwise specified

Parameter	Symbol	Test Condition	Min	Typ	Max	Units	
Static							
Drain-source breakdown voltage	$V_{(BR)DSS}$	$V_{GS} = 0V, I_D = -250\mu A$	-12			V	
Gate-source threshold voltage	$V_{GS(th)}$	$V_{DS} = V_{GS}, I_D = -250\mu A$	-0.5		-0.9	V	
Gate-source leakage	I_{GSS}	$V_{DS} = 0V, V_{GS} = \pm 8V$			± 100	nA	
Zero gate voltage drain current	I_{DSS}	$V_{DS} = -8V, V_{GS} = 0V$			-1	μA	
Drain-source on-state resistance ^{a,e}	$R_{DS(on)}$	$V_{GS} = -4.5V, I_D = -3.5A$		30	45	m Ω	
		$V_{GS} = -2.5V, I_D = -3A$		40	60		
		$V_{GS} = -1.8V, I_D = -2.0A$		60	90		
Forward transconductance ^a	g_{fs}	$V_{DS} = -5V, I_D = -4.1A$	6			S	
Dynamic							
Input capacitance ^{b,c}	C_{iss}	$V_{DS} = -4V, V_{GS} = 0V, f = 1MHz$		740		pF	
Output capacitance ^{b,c}	C_{oss}			290			
Reverse transfer capacitance ^{b,c}	C_{rss}			190			
Total gate charge ^b	Q_g	$V_{DS} = -4V, V_{GS} = -4.5V,$ $I_D = -4.1A$		7.8	15	nC	
		$V_{DS} = -4V, V_{GS} = -2.5V,$ $I_D = -4.1A$		4.5	9		
Gate-source charge ^b	Q_{gs}	$V_{DS} = -4V, V_{GS} = -2.5V,$ $I_D = -4.1A$		1.2			
Gate-drain charge ^b	Q_{gd}			1.6			
Gate resistance ^{b,c}	R_g	$f = 1MHz$	1.4	7	14	Ω	
Turn-on delay time ^{b,c}	$t_{d(on)}$	$V_{DD} = -4V,$ $R_L = 1.2\Omega, I_D \approx -3.3A,$ $V_{GEN} = -4.5V, R_g = 1\Omega$		13	20	ns	
Rise time ^{b,c}	t_r			35	53		
Turn-off Delay time ^{b,c}	$t_{d(off)}$			32	48		
Fall time ^{b,c}	t_f			10	20		
Turn-on delay time ^{b,c}	$t_{d(on)}$		$V_{DD} = -4V,$ $R_L = 1.2\Omega, I_D \approx -3.3A,$ $V_{GEN} = -8V, R_g = 1\Omega$		5		10
Rise time ^{b,c}	t_r			11	17		
Turn-off delay time ^{b,c}	$t_{d(off)}$			22	33		
Fall time ^{b,c}	t_f			16	24		
Drain-source body diode characteristics							
Continuous source-drain diode current	I_S	$T_C = 25^\circ C$			-1.4	A	
Pulse diode forward current ^a	I_{SM}				-10		
Body diode voltage	V_{SD}	$I_F = -3.3A$			-1.2	V	

Note :

- a. Pulse Test ; Pulse Width $\leq 300\mu s$, Duty Cycle $\leq 2\%$.
- b. Guaranteed by design, not subject to production testing.
- c. These parameters have no way to verify.

Typical Characteristics

Output Characteristics

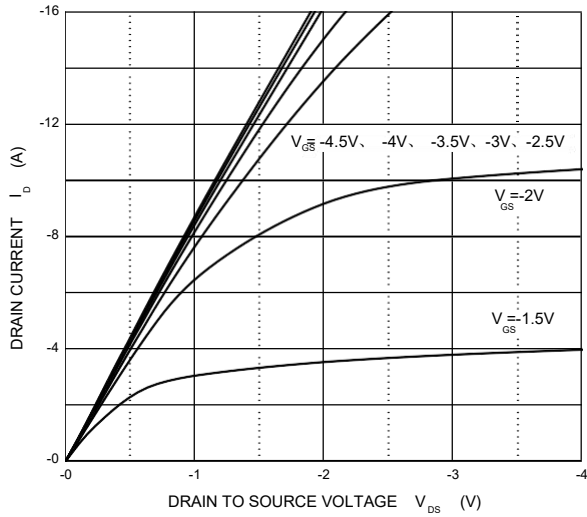

Transfer Characteristics

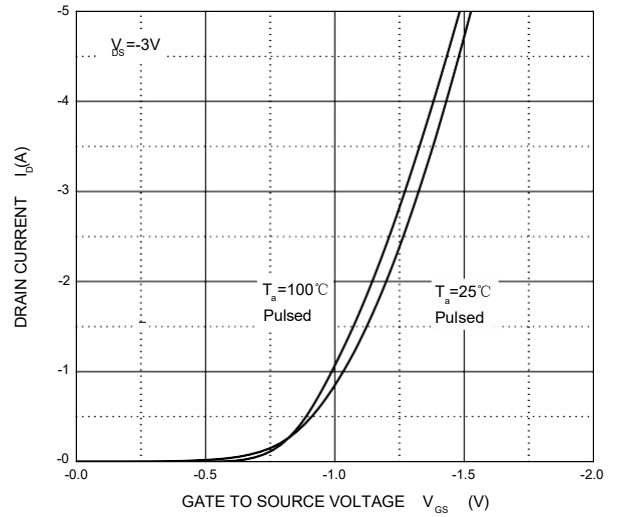

$R_{DS(ON)}$ — I_D

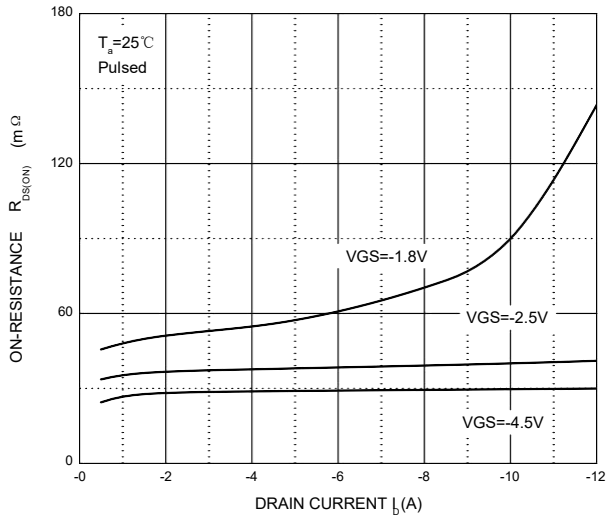

$R_{DS(ON)}$ — V_{GS}

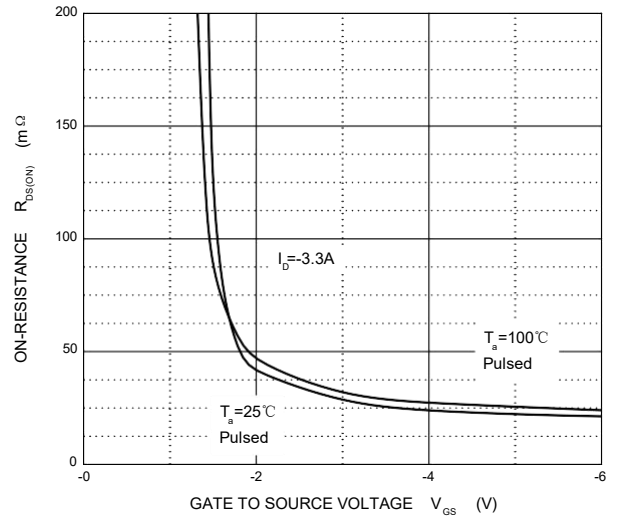

I_S — V_{SD}

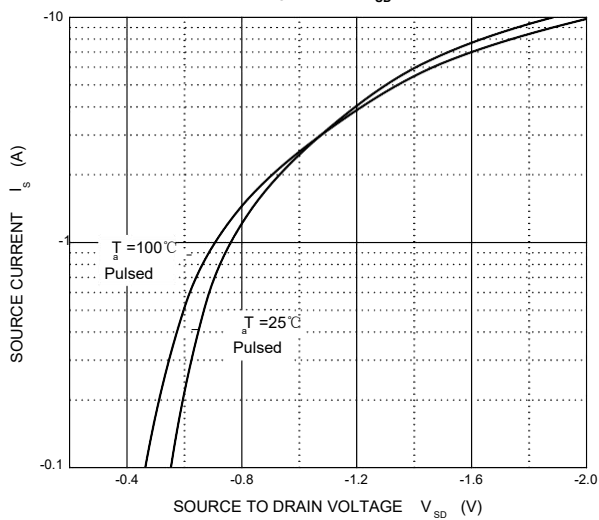

Threshold Voltage

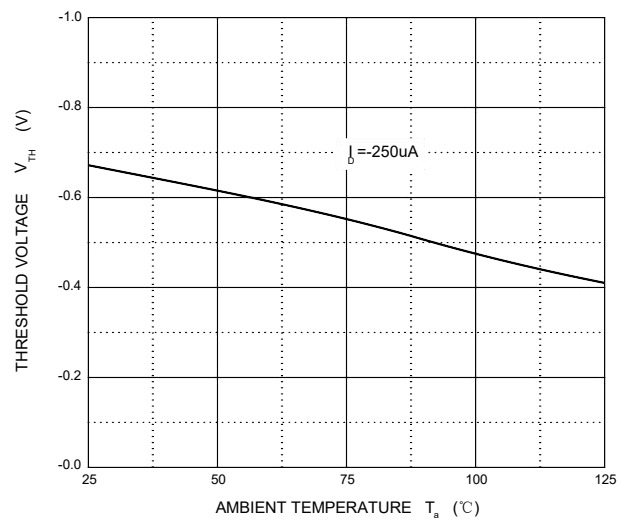

SOT-23 Package Outline Dimensions

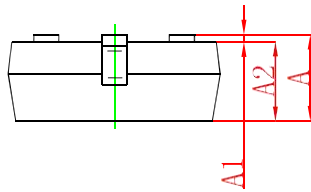
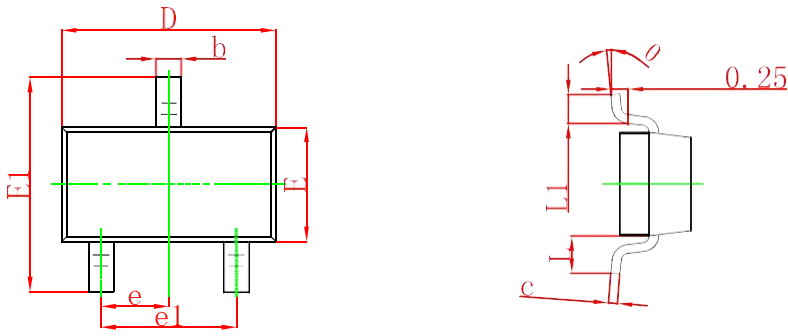

Symbol	Dimensions In Millimeters		Dimensions In Inches	
	Min	Max	Min	Max
A	0.900	1.150	0.035	0.045
A1	0.000	0.100	0.000	0.004
A2	0.900	1.050	0.035	0.041
b	0.300	0.500	0.012	0.020
c	0.080	0.150	0.003	0.006
D	2.800	3.000	0.110	0.118
E	1.200	1.400	0.047	0.055
E1	2.250	2.550	0.089	0.100
e	0.950 TYP		0.037 TYP	
e1	1.800	2.000	0.071	0.079
L	0.550 REF		0.022 REF	
L1	0.300	0.500	0.012	0.020
theta	0°	8°	0°	8°

SOT-23 Suggested Pad Layout

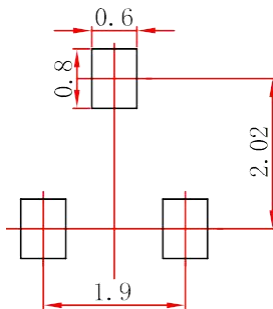

Note:

1. Controlling dimension: in millimeters.
2. General tolerance: $\pm 0.05\text{mm}$.
3. The pad layout is for reference purposes only.

NOTICE

CLOUDCHILD reserves the right to make modifications, enhancements, improvements, corrections or other changes without further notice to any product herein. CLOUDCHILD does not assume any liability arising out of the application or use of any product described herein.

SOT-23 Tape and reel

SOT-23 Embossed Carrier Tape

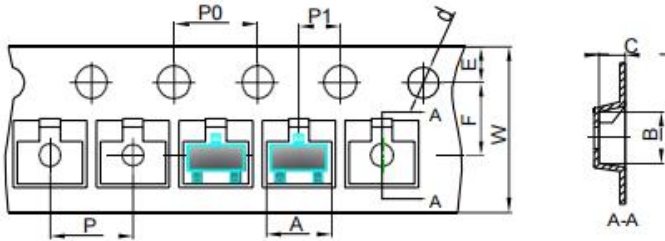

Packaging Description:
 SOT-23 parts are shipped in tape. The carrier tape is made from a dissipative (carbon filled) polycarbonate resin. The cover tape is a multilayer film (Heat Activated Adhesive in nature) primarily composed of polyester film, adhesive layer, sealant, and anti-static sprayed agent. These reeled parts in standard option are shipped with 3,000 units per 7" or 17.8cm diameter reel. The reels are clear in color and is made of polystyrene plastic (anti-static coated).

Dimensions are in millimeter										
Pkg type	A	B	C	d	E	F	P0	P	P1	W
SOT-23	3.15	2.77	1.22	Ø1.50	1.75	3.50	4.00	4.00	2.00	8.00

SOT-23 Tape Leader and Trailer

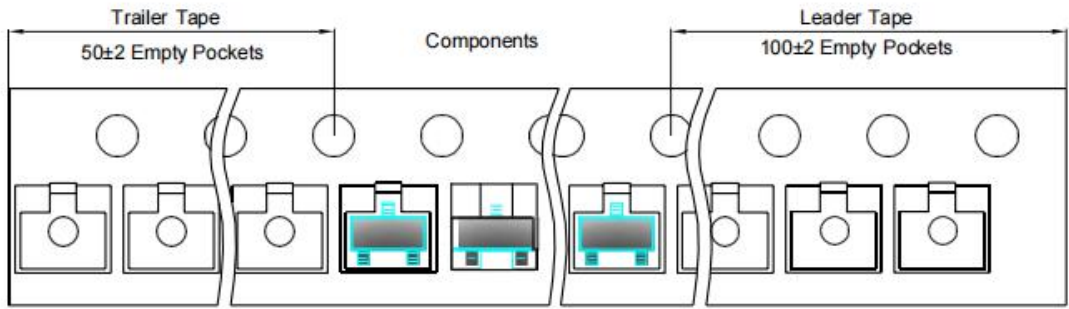

SOT-23 Reel

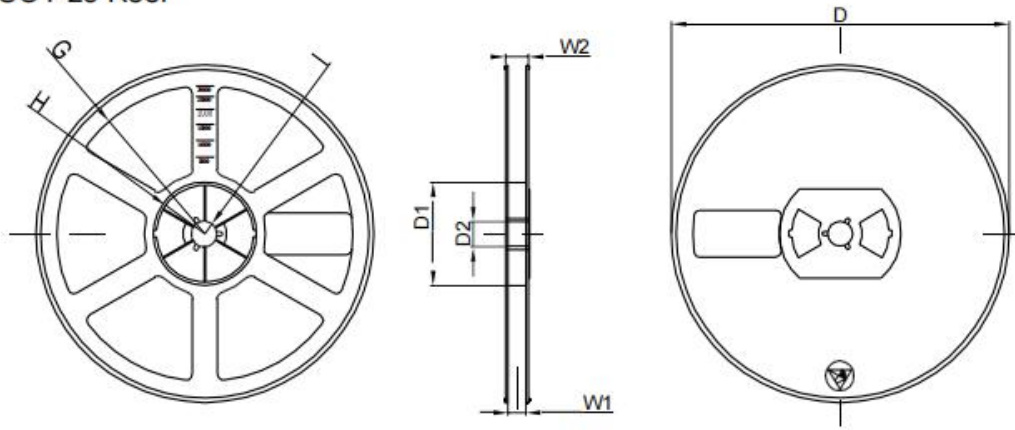

Dimensions are in millimeter								
Reel Option	D	D1	D2	G	H	I	W1	W2
7"Dia	Ø178.00	54.40	13.00	R78.00	R25.60	R6.50	9.50	12.30

REEL	Reel Size	Box	Box Size(mm)	Carton	Carton Size(mm)	G.W.(kg)
3000 pcs	7 inch	30,000 pcs	203×203×195	120,000 pcs	438×438×220	